

DATE	PROJECT	LOCATION	TYPE
------	---------	----------	------



PRODUCT FEATURES

- Seamless Diode Free Illumination
- Ultra Slim
- Field Cut 33.3mm (1.31")
- Bend Direction Horizontal
- Dimmable
- IP67 for Interior and Exterior Applications
- Available in Standard Lengths of 1,2,3,4,5M Reels

PRODUCT SPECIFICATIONS

IP Rate	IP67
Lamp Power	7.7 W/m
Power Input	24V DC
Color Rendering	Ra>90
Operating Temperature Ranges	-20°C to 50°C
Maximum Length	5,000mm (16.4')
Minimum Length	33.3mm (1.31")
Minimum Bending Diameter	30mm(1.18")
Beam Angle	130°
Material	Silicon

SPECIFICATIONS TABLE



Model Number	Color	Lamp Power	Luminous Flux (lm/m)	Lumen/W
FNN1 22K-24V-C90	2200K	7.7 W/m	329.6	42.8 lm/W
FNN1 24K-24V-C90	2400K		333.2	43.3 lm/W
FNN1 27K-24V-C90	2700K		372	48.3 lm/W
FNN1 30K-24V-C90	3000K		423.4	55 lm/W
FNN1 35K-24V-C90	3500K		419.2	54.4 lm/W
FNN1 40K-24V-C90	4000K		375.9	48.8 lm/W

PHYSICAL SPECIFICATIONS

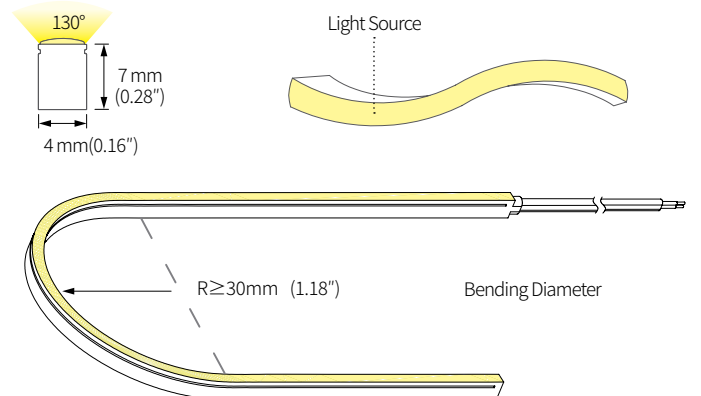

DIMENSIONS

* Straight Feed

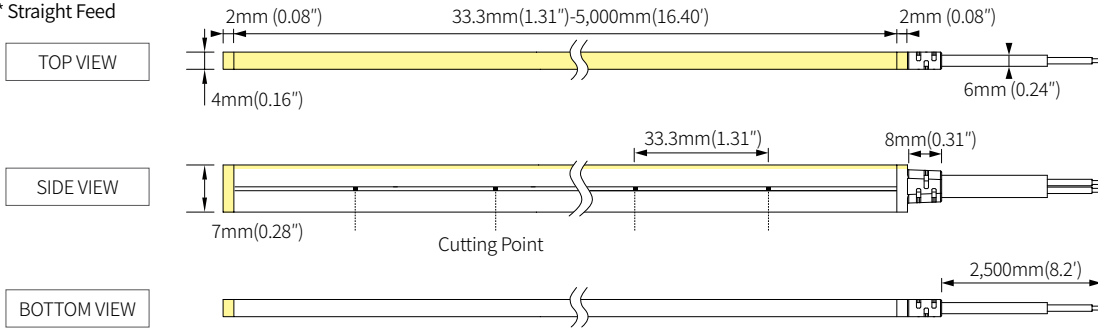

INSTALLATION

* Bracket

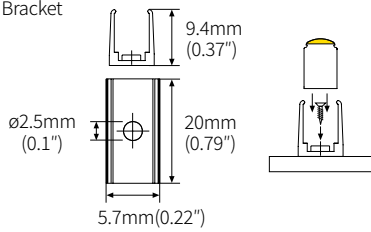

* Bracket & Screw are included every 25cm (9.84")

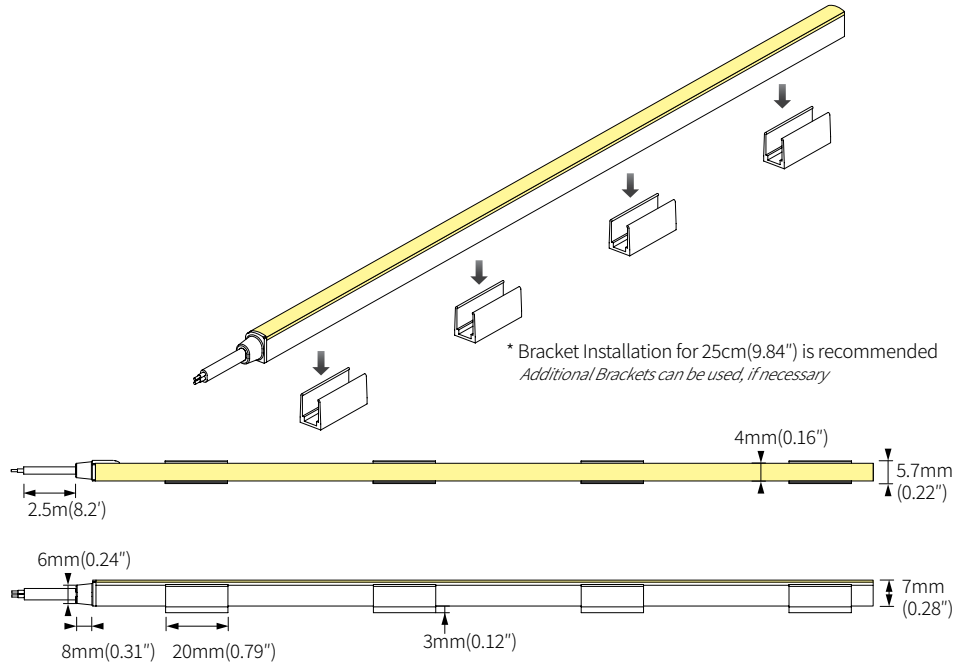
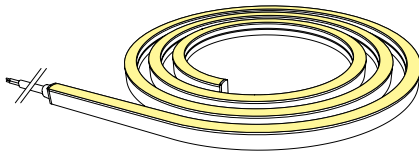

* Extrusion Line

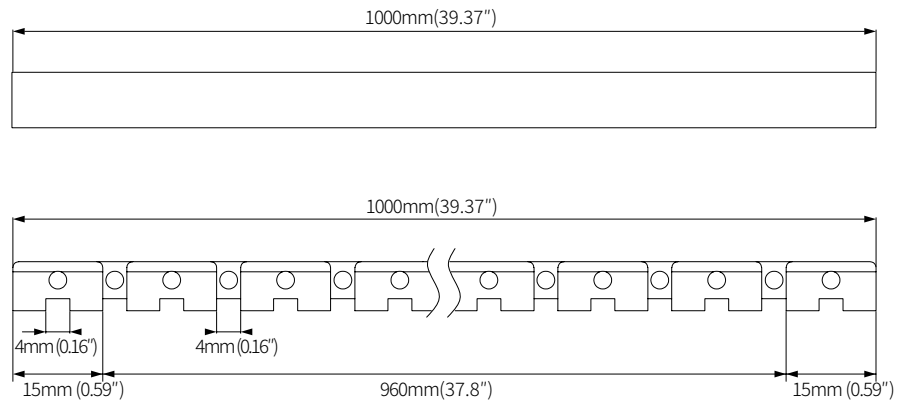
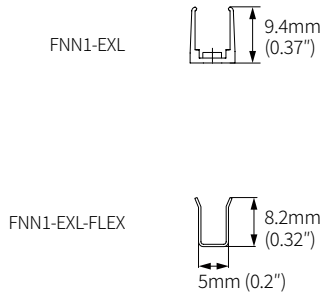

BEAM SPREADS

FNN1 22K-C90-1M
42.8lm/W 329.6lm

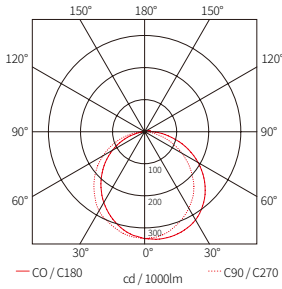

FNN1 24K-C90-1M
43.3lm/W 333.2lm

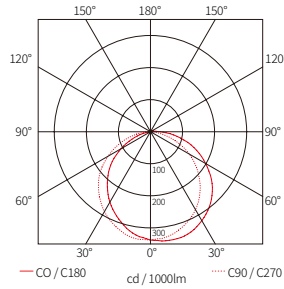

FNN1 27K-C90-1M
48.3lm/W 372lm

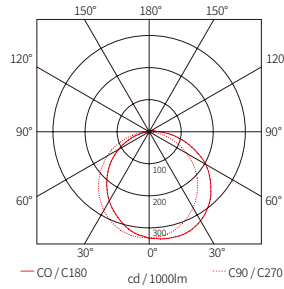

FNN1 30K-C90-1M
55lm/W 423.4lm

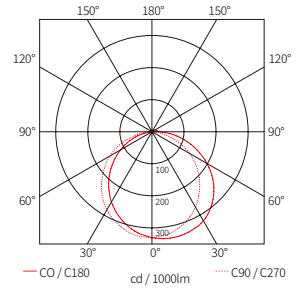

FNN1 35K-C90-1M
54.4lm/W 419.2lm

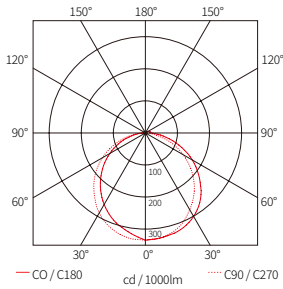

FNN1 40K-C90-1M
48.8lm/W 375.9lm

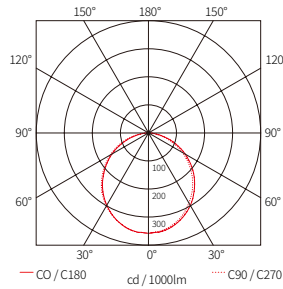

COMPONENTS



FNN1 Narrow

- __ FNN1-(color)K-24V-C90-5M
- __ FNN1-(color)K-24V-C90-4M
- __ FNN1-(color)K-24V-C90-3M
- __ FNN1-(color)K-24V-C90-2M
- __ FNN1-(color)K-24V-C90-1M

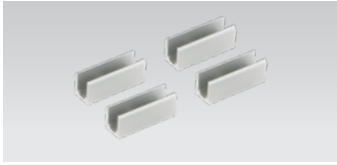

Mounting Brackets

- __ FNN1-BRACKET1

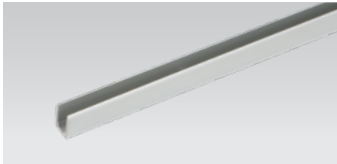

FNN1 Extrusion Line

- __ FNN1-EXL (1,000mm)



FNN1 Flexible Extrusion Line

- __ FNN1-EXL-FLEX (1,000mm)

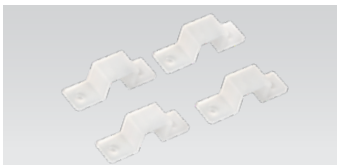

Strap

- __ FNN1-Strap
- *Order Separately



End Cap

- __ FNN1-End Cap
- *Order Separately



12 Port Hub

- __ 12 Way distributor
- Included with Cord and Plug drivers. Order separately for 3rd Party Drivers



LED Drivers

- __ FLC30-24V/T (30W)
- __ FLC75-24V/T (75W)
- with distributor and power cord 1,800mm



LED Driver

- __ FLC200-24V/T (200W)
- with 12way distributor



Dimming Interface (0-10V/1-10V)

- __ FDC-L10 (Max. 100W)



Dimming Interface

- __ FDA-L2MO (0-10V/1-10V, DMX512) Max. 200W (100W/CH, 2CH)
- __ FDA-L5M (DMX512) Max. 200W (50W/CH, 5CH)



Dimming Interface (Dail)

- __ FDD-L1DA
- Max. 200W (100W/CH, 1CH)